

# 2

## Excavation in sand

---

This tutorial describes the construction of an excavation pit in soft clay and sand layers. The pit is a relatively small excavation of 12 by 20 m, excavated to a depth of 6.5 m below the surface. Struts, walings and ground anchors are used to prevent the pit from collapsing. After the full excavation, an additional surface load is added on one side of the pit.

### Objectives

- Using the Hardening Soil model
- Modelling of ground anchors
- Using interface features
- Defining over-consolidation ratio (OCR)
- Prestressing a ground anchor
- Changing water conditions
- Selection of stress points to generate stress/strain curves
- Viewing plastic points

### Geometry

The proposed geometry for this exercise is 80 m wide and 50 m long. The excavation pit is placed in the center of the geometry.

# Excavation in sand

Create a new project

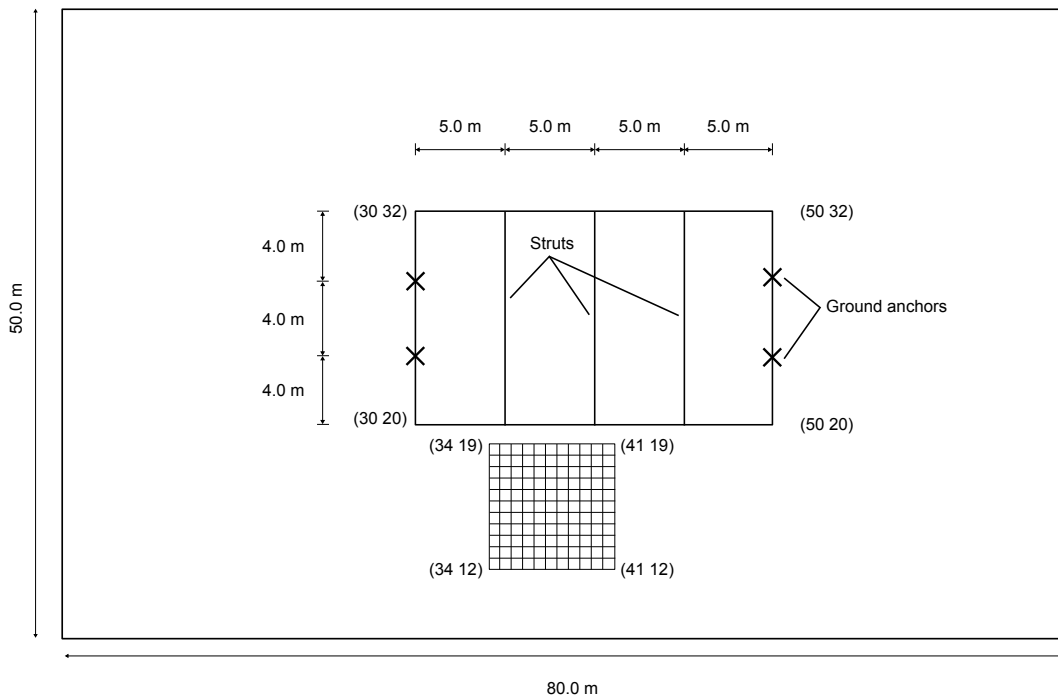

Figure 29: Top view of the excavation pit

The figure below shows a cross section of the excavation pit with the soil layers. The clay layer is considered to be impermeable.

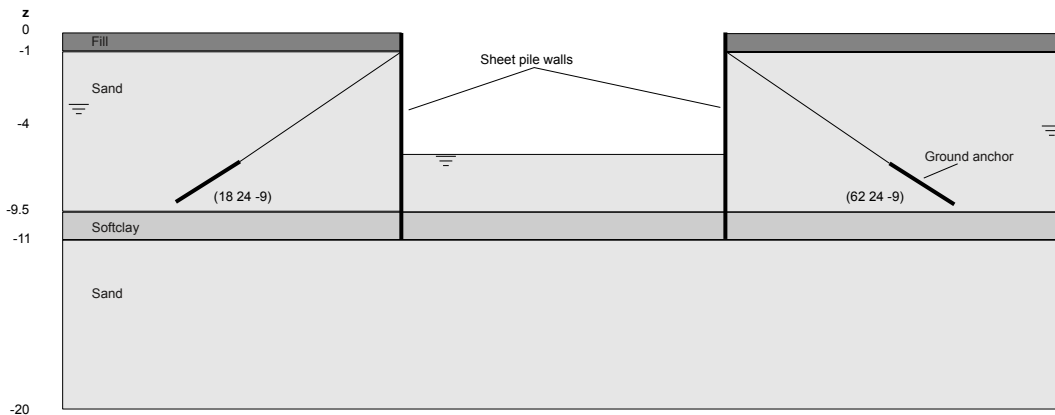

Figure 30: Cross section of the excavation pit with the soil layers

## 2.1 Create a new project

To create the geometry model, follow these steps:

1. Start a new project.

## Excavation in sand

Define the soil stratigraphy

2. Enter an appropriate title for the project.
3. Define the limits for the soil contour as
  - a.  $x_{\min} = 0.0$  and  $x_{\max} = 80.0$ ,
  - b.  $y_{\min} = 0.0$  and  $y_{\max} = 50.0$ .

## 2.2 Define the soil stratigraphy

In order to define the soil layers, a borehole needs to be added and material properties must be assigned. As all soil layers are horizontal, only a single borehole is needed.

1. Click the **Create borehole** button  and create a borehole at (0 0 0).  
The **Modify soil layers** window pops up.
2. Add 4 layers with bottom levels at -1, -9.5, -11, -20.
3. Set the **Head** in the borehole column to -4 m.

## 2.3 Create and assign the material data sets

A number of materials need to be defined for the different soil layers. The material properties are shown in [Table 5](#) (on page 44).

**Table 5: Material properties for the soil layers**

Property	Name	Fill	Sand	Soft Clay	Unit
<b>General</b>					
Soil model	Model	Hardening Soil	Hardening Soil	Hardening Soil	-
Drainage type	Type	Drained	Drained	Undrained A	-
Unsaturated unit weight	$\gamma_{unsat}$	16.0	17.0	16.0	kN/m <sup>3</sup>
Saturated unit weight	$\gamma_{sat}$	20.0	20.0	17.0	kN/m <sup>3</sup>
<b>Mechanical</b>					
Secant stiffness for CD triaxial test	$E_{50}^{ref}$	$2.2 \cdot 10^4$	$4.3 \cdot 10^4$	$2.0 \cdot 10^3$	kN/m <sup>2</sup>
Tangent oedometer stiffness	$E_{oed}^{ref}$	$2.2 \cdot 10^4$	$2.2 \cdot 10^4$	$2.0 \cdot 10^3$	kN/m <sup>2</sup>
Unloading/reloading stiffness	$E_{ur}^{ref}$	$6.6 \cdot 10^4$	$1.29 \cdot 10^5$	$1.0 \cdot 10^4$	kN/m <sup>2</sup>

## Excavation in sand

Create and assign the material data sets

Mechanical					
Poisson's ratio	$v_{ur}$	0.2	0.2	0.2	-
Power for stress level dependency of stiffness	$m$	0.5	0.5	1.0	-
Cohesion	$c'_{ref}$	1	1	5	kN/m <sup>2</sup>
Friction angle	$\varphi' (phi)$	30.0	34.0	25	°
Dilatancy angle	$\psi (psi)$	0.0	4.0	0.0	°
Interfaces					
Strength determination	-	Manual	Manual	Manual	-
Interface reduction factor	$R_{inter}$	0.65	0.7	0.5	-
Initial					
$K_0$ determination	-	Automatic	Automatic	Automatic	-
Pre-overburden pressure	$POP$	0.0	0.0	0.0	-
Over-consolidation ratio	$OCR$	1.0	1.0	1.5	-

1. Click the **Materials** button  in the side toolbar. The **Material sets** window pops up.
2. Create a new data set under **Soil and interfaces** set type.
3. Identify the new data set as **Fill**.
4. From the **Material model** drop-down menu, select **Hardening Soil** model. In contrast with the Mohr-Coulomb model, the Hardening Soil model takes into account the difference in stiffness between virgin-loading and unloading-reloading. For a detailed description of the Hardening Soil model, see the [Material Models Manual](#).
5. Define the saturated and unsaturated unit weights according to [Table 5](#) (on page 44).
6. In the **Mechanical** tabsheet, enter values for  $E_{50}^{ref}$ ,  $E_{oed}^{ref}$ ,  $E_{ur}^{ref}$ ,  $m$ ,  $c'_{ref}$ ,  $\varphi'_{ref}$ ,  $\psi$  and  $v'_{ur}$ .
7. As no consolidation will be considered in this exercise, the permeability of the soil will not influence the results. Therefore, the default values can be kept in the **Groundwater** tabsheet.
8. In the **Interfaces** tabsheet, in the **Strength** box select **Manual** and enter a value of 0.65 for the parameter  $R_{inter}$ .

This parameter relates the strength of the interfaces to the strength of the soil, according to the equations:

$$c_i = R_{inter}c_{soil} \text{ and } \tan\varphi_i = R_{inter} \tan\varphi_{soil}$$

Hence, using the entered  $R_{inter}$ -value gives a reduced interface friction and interface cohesion (adhesion) compared to the friction angle and the cohesion in the adjacent soil.

## Excavation in sand

Define the structural elements

### Note:

- When the **Rigid** option is selected in the **Strength** drop-down list, the interface has the same strength properties as the soil ( $R_{inter} = 1.0$ ).
- Note that a value of  $R_{inter} < 1.0$ , reduces the strength as well as the stiffness of the interface (for more information see the [Reference Manual](#) ).

9. In the **Initial** tabsheet, define the OCR-value according to [Table 5](#) (on page 44).
10. Click **OK** to close the window.
11. After closing the **Material sets** window, click the **OK** button to close the **Modify soil layers** window.
12. In the **Soil mode** right-click the upper soil layer. Select **Soil\_1 > Set material > Fill**.
13. In the same way assign the **Soft Clay** material to the soil layer between  $y = -9.5$  m and  $y = -11.0$  m.
14. For the remaining two soil layers assign the **Sand** material.

**Note:** The **Tension cut-off** option is activated by default at a value of  $0 \text{ kN/m}^2$ . This option is found in the tabsheet **Mechanical > Strength > Tension**. Here the **Tension cut-off** value can be changed or the option can be deactivated entirely.

## 2.4 Define the structural elements

The creation of walings and struts, ground anchors, sheet pile walls and surface loads is described below.

### 2.4.1 Walings and Struts

The material properties for the structural elements are shown in the [Table 6](#) (on page 46) . These are needed for defining the material in a later step.







**Table 6: Material properties of waling and strut**

Property	Name	Strut	Waling	Unit
<b>General</b>				
Material type	Type	Elastic	Elastic	-
Unit weight	$\gamma$	78.5	78.5	$\text{kN/m}^3$
<b>Mechanical</b>				
Cross section type	Type	User-defined	User-defined	-
Cross section area	$A$	0.007367	0.008682	$\text{m}^2$

## Excavation in sand

Define the structural elements

Mechanical				
Moment of Inertia	$I_2$	$5.073 \cdot 10^{-5}$	$3.66 \cdot 10^{-4}$	$m^4$
	$I_3$	$5.073 \cdot 10^{-5}$	$1.045 \cdot 10^{-4}$	$m^4$
Young's modulus	$E$	$2.1 \cdot 10^8$	$2.1 \cdot 10^8$	$kN/m^2$

1. Click the **Structures** tab to proceed with the input of structural elements in the **Structures mode**.
2.  Create a surface between (30 20 0), (30 32 0), (50 32 0) and (50 20 0).
3.  Extrude the surface to  $z = -1$ ,  $z = -6.5$  and  $z = -11$ .
4. Right-click on the deepest created volume (between  $z = 0$  and  $z = -11$ ) and select **Decompose into surfaces**.
5. Delete the top surfaces (2 surfaces).  
An extra surface is created as the volume is decomposed.
6. Hide the excavation volumes (do not delete).  
The eye button in the **Model explorer** and the **Selection explorer** trees can be used to hide parts of the model and simplify the view. A hidden project entity is indicated by a closed eye.
7. Click the **Create structure** button .
8.  Create beams (*walings*) around the excavation perimeter at level  $z = -1$ m. Press **<Shift>** and keep it pressed while moving the mouse cursor in the  $-z$ -direction. Stop moving the mouse as the  $z$ -coordinate of the mouse cursor is  $-1$  in the cursor position indicator. Note that as you release **<Shift>**, the  $z$ -coordinate of the cursor location does not change. This is an indication that you can draw only on the  $xy$ -plane located at  $z = -1$ .
9. Click on (30 20 -1), (30 32 -1), (50 32 -1), (50 20 -1), (30 20 -1) to draw the walings. Click on the right mouse button to stop drawing walings.
10.  Create a beam (*strut*) between (35 20 -1) and (35 32 -1). Press **<Esc>** to end defining the strut.
11.  Create data sets for the walings and struts according to [Table 6](#) (on page 46) and assign the materials accordingly.
12.  Copy the strut into a total of three struts at  $x = 35$  (existing),  $x = 40$ , and  $x = 45$ .

The created struts and walings can be seen in [Figure 31](#) (on page 48)

## Excavation in sand

Define the structural elements

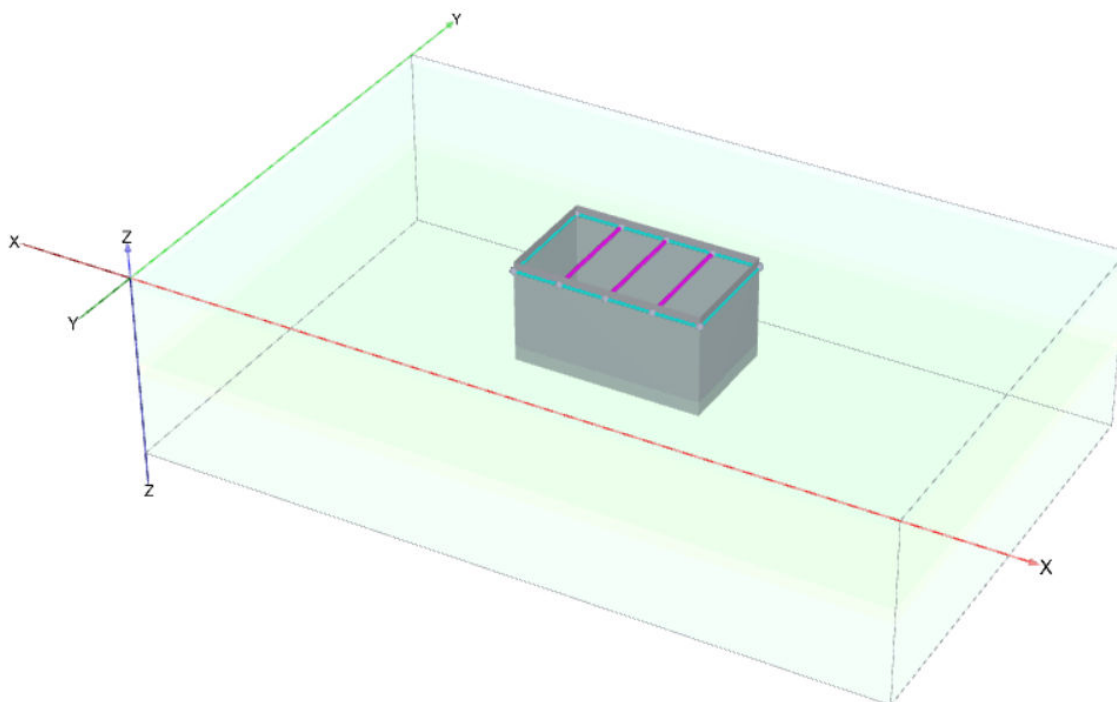

Figure 31: Visualization of struts and walings - Structures mode

### 2.4.2 Ground anchors

The material properties for the structural elements are shown in [Table 7](#) (on page 48) and [Table 8](#) (on page 48). These are needed for defining the material in a later step.

**Table 7: Material properties of the node-to-node anchors**

Property	Name	Node-to-node anchor	Unit
Material type	Type	Elastic	-
Axial stiffness	$EA$	$6.5 \cdot 10^5$	kN

**Table 8: Material properties of the embedded beams (grout body)**





Property	Name	Grout	Unit
<b>General</b>			
Material type	Type	Elastic	-
Unit weight	$\gamma$	24	kN/m <sup>3</sup>

## Excavation in sand

Define the structural elements

Mechanical			
Cross section type	Type	Predefined	-
Predefined cross section type	Type	Solid circular beam	-
Diameter	-	0.14	m
Young's modulus	$E$	$3 \cdot 10^7$	kN/m <sup>2</sup>
Axial skin resistance	Type	Linear	-
Skin resistance at the top of the embedded beam	$T_{skin,start,max}$	200	kN/m
Skin resistance at the bottom of the embedded beam	$T_{skin,end,max}$	0.0	kN/m
Base resistance	$F_{max}$	0.0	kN



In PLAXIS 3D ground anchors can be modelled using the Node-to-node anchor and the Embedded beam options as described as follows:

-  First the ungrouted part of the anchor is created using the Node-to-node anchor feature. Start creating the structure by clicking the create line on the side tool bar and selecting the **Create node-to-node anchor** button.
  - To create the ungrouted part of the first ground anchor click on the command line and type 30 24 -1 21 24 -7. Press **<Enter>** and **<Esc>**
  - Create a node-to-node anchor between the points (50 24 -1) and (59 24 -7).
  -  The *grouted part of the anchor* is created using the **Embedded beam** option. Create embedded beams between (21 24 -7) and (18 24 -9) and between (59 24 -7) and (62 24 -9). Set the Behaviour to Grout body (for more information see the [Reference Manual](#) ).
  -  Create a data set for the embedded beam and a data set for the node-to-node anchor according to [Table 7](#) (on page 48) and [Table 8](#) (on page 48) respectively. Assign the data sets to the node-to-node anchors and to the embedded beams.
- Note:** The colour indicating the material set assigned to the entities in project can be changed by clicking on the Colour box of the selected material set and selecting a colour from the **Colour** part of the window.
- The remaining grouted anchors will be created by copying the defined grouted anchor. Click on the Select button and click on all the elements composing both of the ground anchors keeping **<Ctrl>** pressed.
  -  Use the Create array function to copy both ground anchors (2 embedded beams + 2 node-to-node anchors) into a total of 4 complete ground anchors located at  $y = 24$  and  $y = 28$ . To do this, inside the array function on the Shape drop-down menu select the 1D in y direction option, then define number of columns as 2 and the Distance between columns as 4 m.



## Excavation in sand

Define the structural elements

8.  Multi-select all parts of the ground anchors (8 entities in total). While all parts are selected and **<Ctrl>** is pressed, right-click and select **Group**.
9.  In the **Model explorer** tree, expand the **Groups** subtree by clicking on the (+) in front of the groups.
10. Click the Group\_1 and rename it to GroundAnchors.

**Note:** The name of the entities in the project should not contain any space or special character except \_ (underscore).

### 2.4.3 Pile sheet walls and loads

The material properties for the structural elements are shown in the table below. These are needed for defining the material in a later step.

**Table 9: Material properties of pile sheet walls**

Parameter	Name	Sheet pile wall	Unit
<b>General</b>			
Type of behaviour	Type	Elastic	-
Weight	$\gamma$	2.55	kN/m <sup>3</sup>
<b>Mechanical</b>			
Isotropic	-	No	-
Young's modulus	$E_1$	$1.46 \cdot 10^7$	kN/m <sup>2</sup>
	$E_2$	$7.3 \cdot 10^5$	kN/m <sup>2</sup>
Poisson's ratio	$\nu_{12}$	0.0	-
Thickness	$d$	0.379	m
Shear modulus	$G_{12}$	$7.3 \cdot 10^5$	kN/m <sup>2</sup>
	$G_{13}$	$1.27 \cdot 10^6$	kN/m <sup>2</sup>
	$G_{23}$	$3.82 \cdot 10^5$	kN/m <sup>2</sup>

To define the sheet pile walls and the corresponding interfaces, follow these steps:

1.  Select all four vertical surfaces created as the volume was decomposed. Keeping **<Ctrl>** pressed, right-click and select **Create > Create plate** option from the appearing menu.

## Excavation in sand

Define the structural elements

-  Create a data set for the sheet pile walls (plates) according to [Table 9](#) (on page 50). Assign the data sets to the four walls.
- As all the surfaces are selected, assign *both* positive and negative interfaces to them using the options in the right mouse button menu (**Create > Create positive interface/Create negative interface**).

**Note:** The term 'positive' or 'negative' for interfaces has no physical meaning. It only enables distinguishing between interfaces at each side of a surface.

- Non-isotropic (different stiffness in two directions) sheet pile walls are defined. The local axis should point in the correct direction (which defines which is the 'stiff' or the 'soft' direction). As the vertical direction is generally the stiffest direction in sheet pile walls, local axis 1 shall point in the z-direction.

To consider the non-isotropic behaviour in the geometry, in the **Model explorer** tree  expand the subtrees **Geometry > Surfaces > Polygon\_Volume\_3\_2** and set **AxisFunction** to Manual and set Axis1<sub>z</sub> to -1. Do this for all the pile wall surfaces.

**Note:**

- The first local axis is indicated by a red arrow, the second local axis is indicated by a green arrow and the third axis is indicated by a blue arrow. More information related to the local axes of plates is given in the [Reference Manual](#).

-  Create a surface load defined by the points: (34 19 0), (41 19 0), (41 12 0), (34 12 0). The geometry is now completely defined (see [Figure 32](#) (on page 51)).

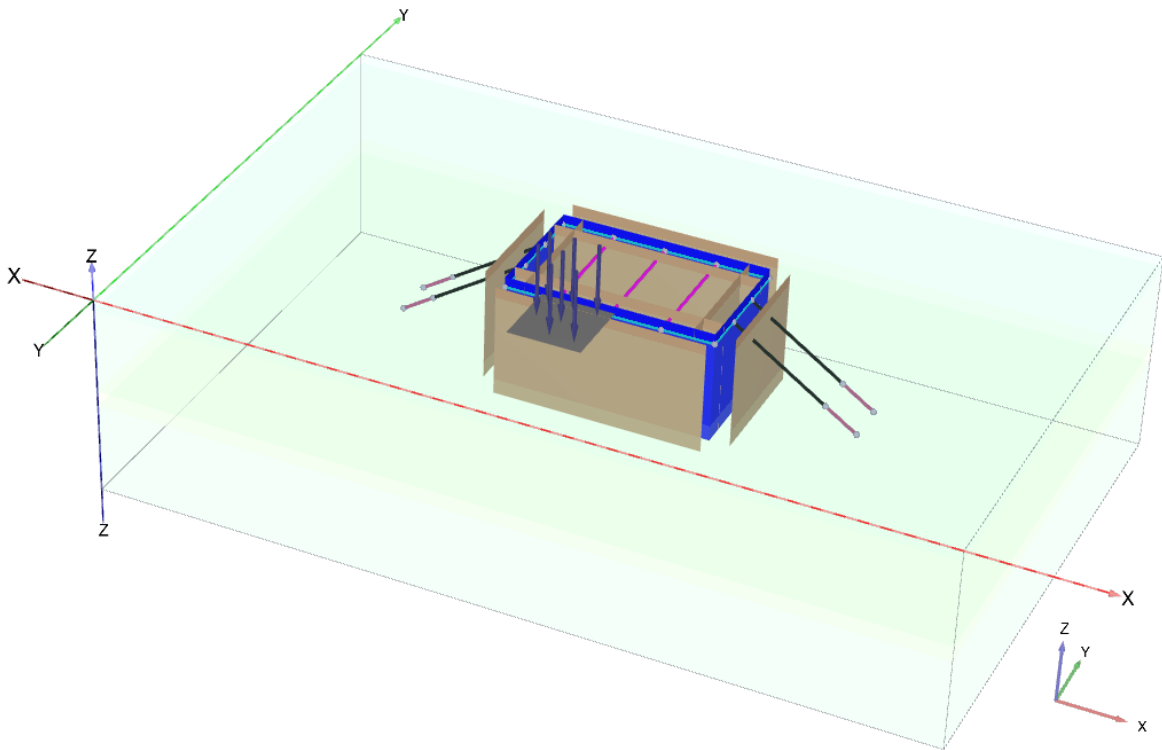



Figure 32: Structure mode - Complete project geometry

## Excavation in sand

Generate the mesh

---

### 2.5 Generate the mesh

1. Proceed to the **Mesh Mode**.
2. Select the surface representing the excavation. Then in the **Selection explorer** set the value of **Coarseness factor** to 0.25.
3. Set the element distribution to **Coarse**. Uncheck the box for **Enhanced mesh refinements**. Click the **Generate mesh** button  to generate the mesh.

**Note:** The **Enhanced mesh refinements** are automatically used in mesh generation. More information is available in the [Reference Manual](#).

4. Click the **View mesh** button  to view the mesh. Hide the soil in the model to view the embedded beams.
5. Click on the **Close** tab to close the Output program and go back to the **Mesh mode** of the Input program.



### 2.6 Define the calculation

The calculation consists of *6 phases*. The initial phase consists of the generation of the initial stresses using the **K0 procedure**. The next phase consists of the installation of the sheet piles and a first excavation. Then the walings and struts will be installed. In phase 3, the ground anchors will be activated and prestressed. Further excavation will be performed in the phase after that. The last phase will be the application of the additional load next to the pit.

1. Click on the **Staged construction** tab to proceed with definition of the calculation phases.
2. The initial phase has already been introduced. Keep its calculation type as **K0 procedure**. Make sure all the soil volumes are active and all the structural elements are inactive.
3.  Add a new phase (Phase\_1). The default values of the parameters will be used for this calculation phase.
4. Deactivate the first excavation volume (from  $z=0$  to  $z=-1$ ).
5. In the **Model explorer**, activate all plates and interfaces by clicking on the checkbox in front of them.



The active elements in the project are indicated by a green check mark in the **Model explorer**.

**Note:** To visualize more clearly the activated elements the soil layers can be hidden, this can be done by right clicking the soil volume of interest and selecting **Hide**.

6.  Add a new phase (Phase\_2). The default values of the parameters will be used for this calculation phase.
7. In the **Model explorer** activate all the beams.
8.  Add a new phase (Phase\_3). The default values of the parameters will be used for this calculation phase.
9. In the **Model explorer** activate the **GroundAnchors** group.

## Excavation in sand

Define the calculation

10.  Select one of the node-to-node anchors.
11.  In the **Selection explorer** expand the node-to node anchor features.
12. Click on the **Adjust prestress** checkbox. Enter a prestress force of 200kN as displayed in [Figure 33](#) (on page 53).

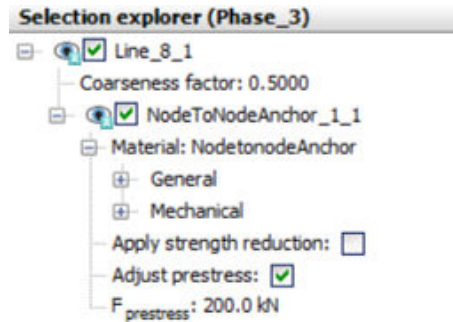





Figure 33: Node-to-node anchor in the Selection explorer

13. Do the same for all the other node-to-node anchors.
14.  Add another phase (Phase\_4). The default values of the parameters will be used for this calculation phase.
15.  Select the soil volume to be excavated in this phase (between  $z=-1$  and  $z=-6.5$ ).
16.  In the **Selection explorer** under **WaterConditions** feature, click on the **Conditions** and select the **Dry** option from the drop-down menu as in [Figure 34](#) (on page 53).

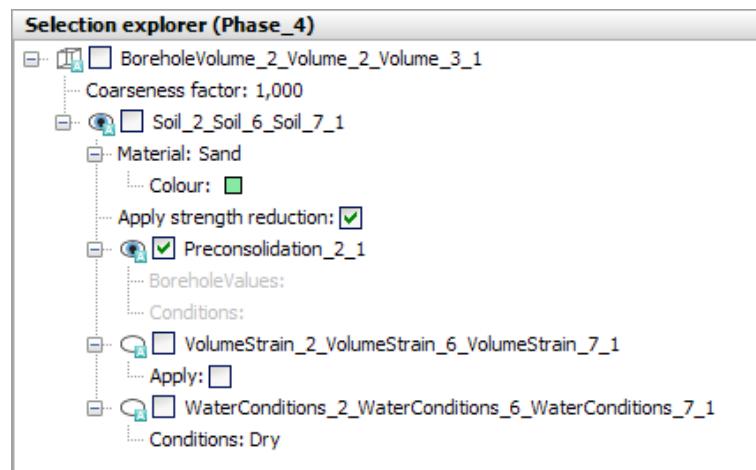





Figure 34: Water conditions in the Selection explorer

17. Deactivate the volume to be excavated (between  $z = -1$  and  $z = -6.5$ ).
18. Hide the soil and the plates around the excavation.

## Excavation in sand

Define the calculation

19.  Select the soil volume below the excavation (between  $z = -6.5$  and  $z = -9.5$ ).
20. In **Selection explorer** under **WaterConditions** feature, click **Conditions** and select **Head** from the drop-down menu. Enter  $z_{\text{ref}} = -6.5$  m.
21.  Select the soft clay volume below the excavation.
22. Set the water conditions to **Interpolate**.
23.  Preview this calculation phase.
24.  Click the **Vertical cross section** button in the **Preview** window and define the cross section by drawing a line across the middle of excavation.

**Note:** Hold <Shift> when drawing to get a straight line.

25. From **Stresses > Pore pressures** menu select the  $p_{\text{steady}}$  option.
26.  Display the contour lines for steady pore pressure distribution. Make sure that the **Legend > View** option is checked. The steady state pore pressure distribution is displayed in [Figure 35](#) (on page 54). Scroll the wheel button of the mouse to zoom in or out to get a better view.
27. Change the legend settings to:
  - Scaling: manual
  - Maximum value: 0
  - Number of intervals: 18

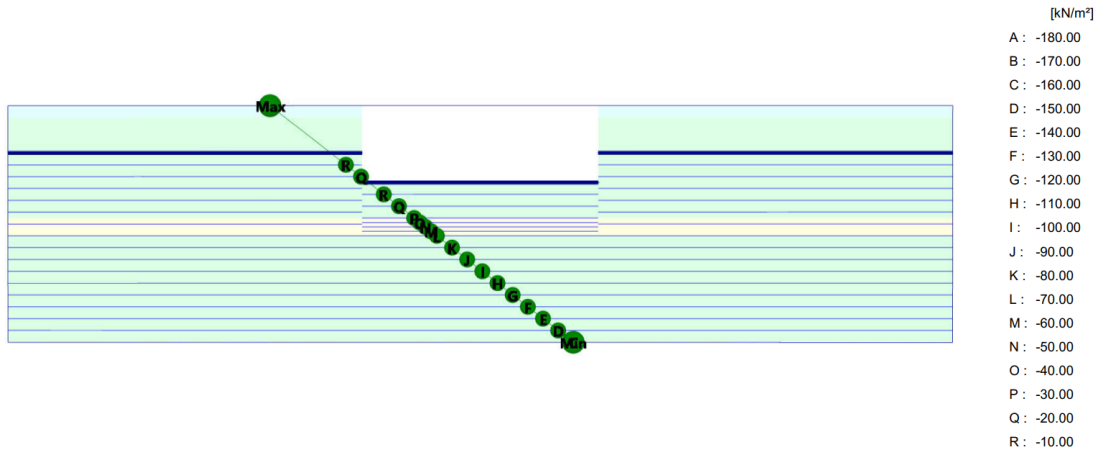



Figure 35: Preview of the steady state pore pressures in Phase\_4 in a cross section



28. Click on the **Close** button to return to the Input program.
29.  Add another phase (Phase\_5). The default values of the parameters will be used for this calculation phase.
30. Activate the surface load and set  $\sigma_z = -20$  kN/m<sup>2</sup>.

### 2.6.1 Execute the calculation

Before starting the calculation process, some stress points next to the excavation pit and loading are selected to plot a stress strain curve later on.

1. Click the **Select points for curves** button .  
The model and **Select points** window will be displayed in the Output program.
2. Define (37.5 19 -1.5) as **Point-of-interest coordinates**.

**Note:** The visualization settings can be changed from the menu. For more information refer to [Reference Manual](#).

3. Click the **Search closest** button.  
The number of the closest node and stress point will be displayed.
4. Click the checkbox in front of the stress point to be selected.  
The selected stress point will be shown in the list.
5. Select also stress points near the coordinates (37.5 19 -5), (37.5 19 -6) and (37.5 19 -7) and close the **Select points** window.
6. Click the **Update** button to close the Output program.
7.  Start the calculation process.
8.  Save the project when the calculation is finished.

**Note:**

- Instead of selecting nodes or stress points for curves before starting the calculation, points can also be selected after the calculation when viewing the output results. However, the curves will be less accurate since only the results of the saved calculation steps will be considered.
- To plot curves of structural forces, nodes can only be selected after the calculation.
- Nodes or stress points can be selected by just clicking them. When moving the mouse, the exact coordinates of the position are given in the cursor location indicator bar at the bottom of the window.

## 2.7 Results

After the calculations, the results of the excavation can be viewed by selecting a calculation phase from the **Phases** tree and pressing the **View calculation results** button.

1.  Select the final calculation phase (Phase\_5) and click the **View calculation results** button.  
The Output program will open and will show the deformed mesh at the end of the last phase.
2. The stresses, deformations and three-dimensional geometry can be viewed by selecting the desired output from the corresponding menus. For example, choose the menu **Stresses > Plastic points** to investigate the plastic points in the model.

## Excavation in sand

### Results

3. In the **Plastic points** window, select all the options except the **Elastic points** and the **Show only inaccurate points** options (See [Figure 36](#) (on page 56)).

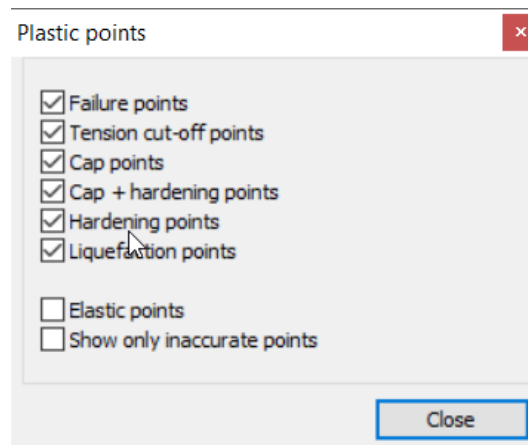

Figure 36: Plastic points window

The figure below shows the plastic points generated in the model at the end of the final calculation phase.

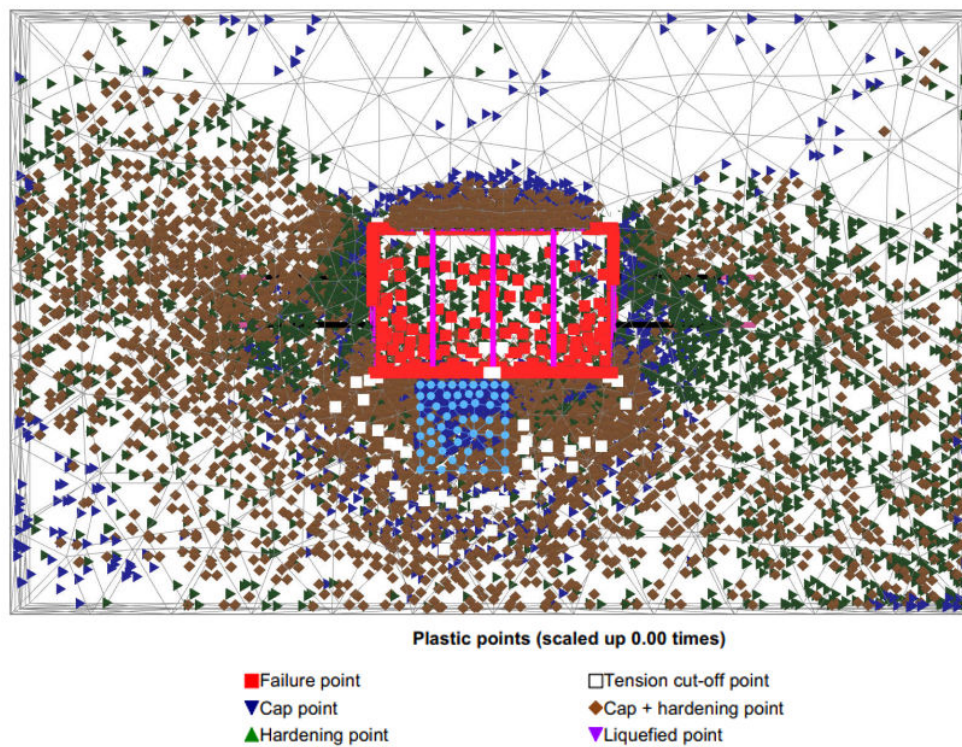

Figure 37: Plastic points at the end of the final phase

The graph will now show the major principal strain against the major principal stress. Both values are zero at the beginning of the initial conditions. After generation of the initial conditions, the principal strain is still zero whereas the principal stress is not zero anymore. To plot the curves of all selected stress points in one graph, follow these steps:

# Excavation in sand

## Results

1. Click on **Curves manager** option and a window pops up. Click on **New** and select the stress points for X-Axis and Y-Axis as shown in [Figure 38](#) (on page 57).
2. Right-click and select **Add curve > From current project**.
3. Generate curves for the three remaining stress nodes in the same way.

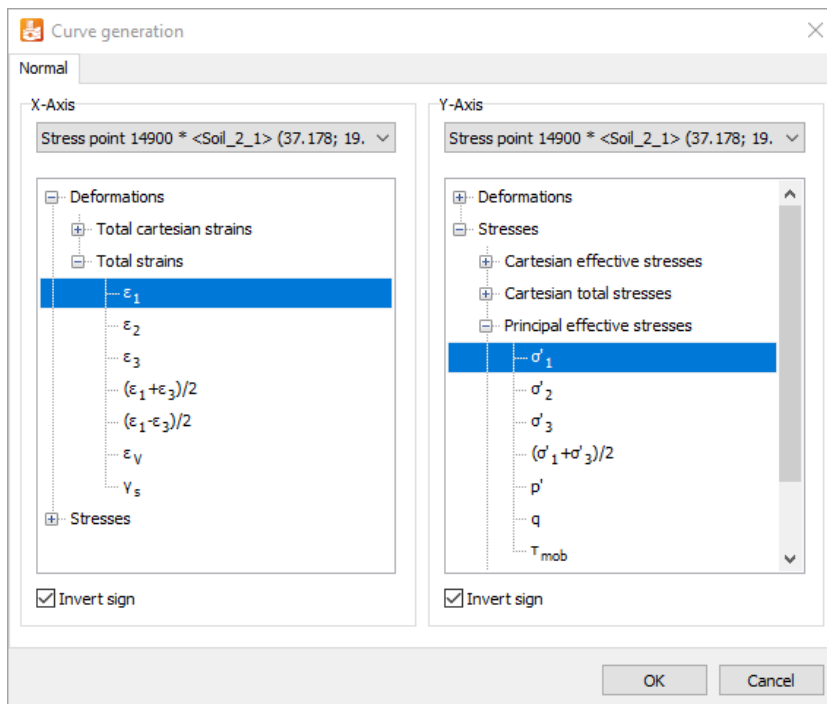

Figure 38: Curve generation window

The graph will now show the stress-strain curves of all four stress points.



# Excavation in sand

## Results

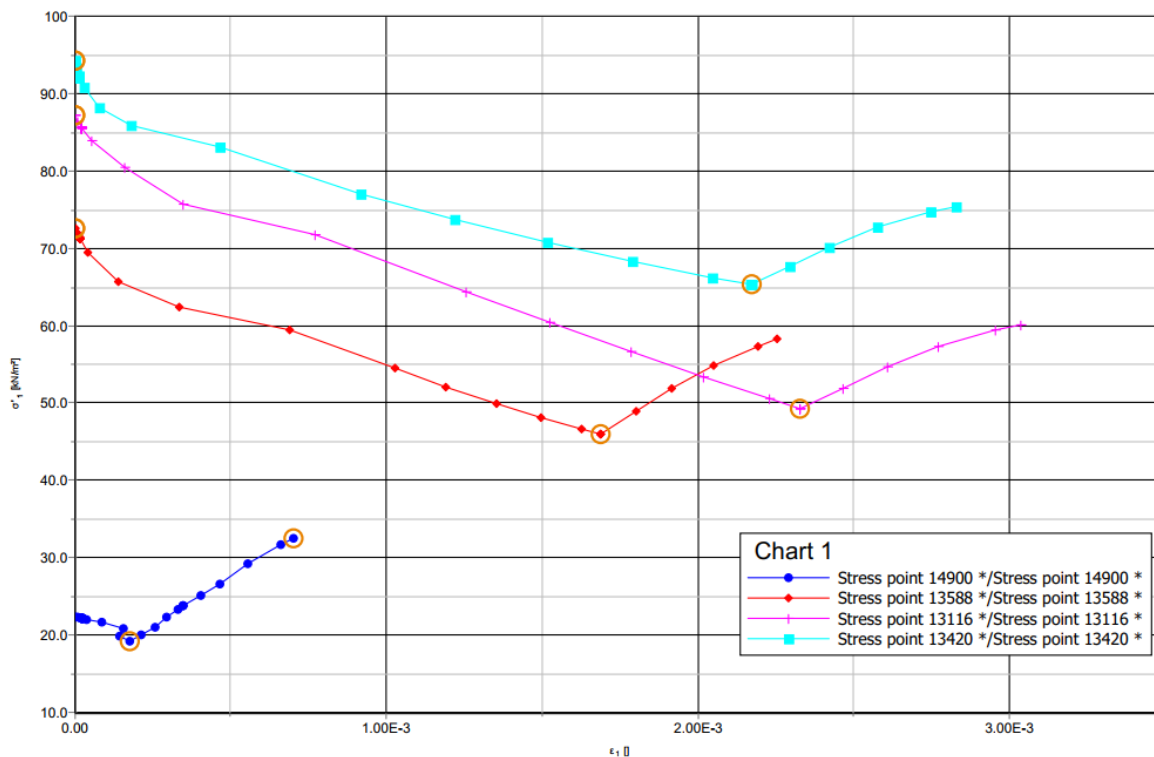

Figure 39: Stress - Strain curve

To see information about the markers, make sure the menu item **View > Value indication** is checked and hold the mouse on a marker for a while. Information about the coordinates in the graph, the number of the point in the graph, the number of the phase and the number of the step is given. Especially the lower stress points show a considerable increase in the stress when the load is applied in the last phase.

### Note:

- To re-enter the **Curve generation** window (in the case of a mistake, a desired regeneration or a modification), select the menu item **Format > Curve settings**. As a result the **Curves settings** window appears, on which the **Regenerate** button should be clicked.
- The menu item **Format > Chart settings** menu may be used to modify the settings of the chart.

To create a stress path plot for stress node (37.5 19 -1.5) follow these steps:

1. Create a new chart.
2. In the **Curves generation** window, select node (37.5 19 -1.5) from the drop-down menu of the x-axis of the graph and  $\sigma'_{yy}$  under **Cartesian effective stresses**.
3. Select node (37.5 19 -1.5) from the drop-down menu of the y-axis of the graph. Select  $\sigma'_{zz}$  under **Cartesian effective stresses**.
4. Click **OK** to confirm the input.

# Excavation in sand

## Results

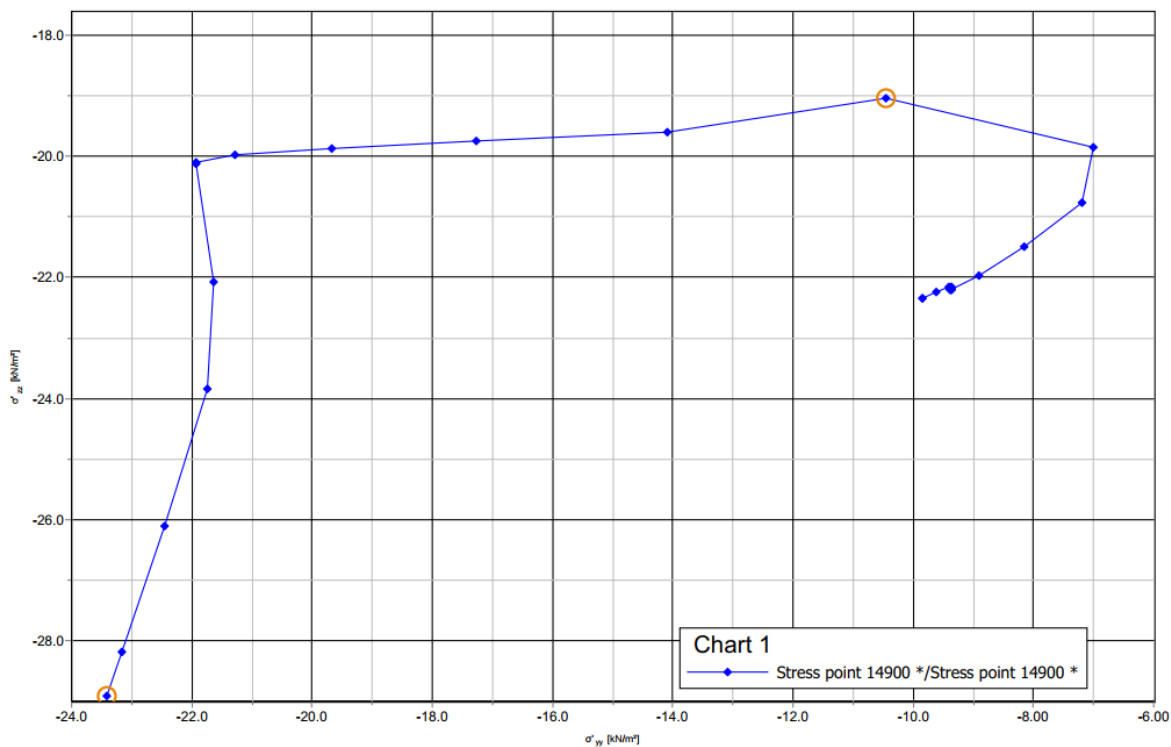

Figure 40: Vertical effective stress ( $\sigma'_{yy}$ ) versus horizontal effective stress ( $\sigma'_{yy}$ ) at stress node located near (37.5 19 -1.5)