PLAXIS

CONNECT Edition V21.01

PLAXIS 2D - Tutorial Manual - Excavation of an NATM tunnel [GSE]



Last Updated: March 16, 2021

Excavation of an NATM tunnel [GSE]

This tutorial illustrates the use of PLAXIS 2D for the analysis of the construction of a NATM tunnel. The NATM is a technique in which ground exposed by excavation is stabilised with shotcrete to form a temporary lining.

Objectives

- Modelling the construction of an NATM tunnel using the **Deconfinement** method.
- Using **Gravity loading** to generate initial stresses.

Geometry

The geometry of the tunnel project looks like this:

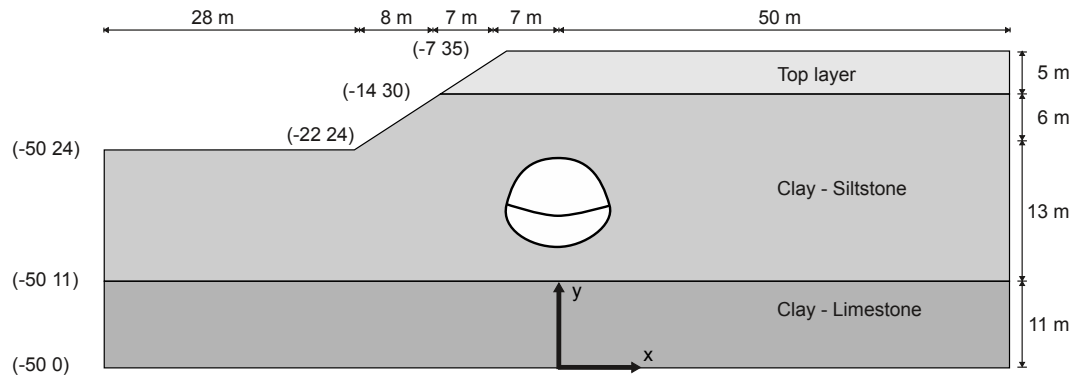

Figure 1: Geometry of the project

Create a new project

To create a new project, follow these steps:

1. Start the Input program and select **Start a new project** from the **Quick start** dialog box.
2. In the **Project** tabsheet of the **Project properties** window, enter an appropriate title.
3. In the **Model** tabsheet make sure that **Model** is set to **Plane strain** and that **Elements** is set to **15-Noded**.
4. Define the limits for the soil contour as $x_{\min} = -50$ m, $x_{\max} = 50$ m, $y_{\min} = 0$ m and $y_{\max} = 35$ m.

Define the soil stratigraphy

Excavation of an NATM tunnel [GSE]

Define the soil stratigraphy

The basic stratigraphy will be created using the **Borehole** feature. In the model 11 m of the Clay-limestone layer is considered. The bottom of this layer is considered as reference in y direction ($y_{\min} = 0$).

To define the soil stratigraphy:

1. Click the **Create borehole** button  and create the first borehole at $x = -22$ m.
2. In the **Modify soil layers** window create three soil layers.
 - a. The layer number 1 has a depth equal to zero in Borehole_1. Assign 24 to **Top** and **Bottom**.
 - b. The layer number 2 lies from **Top** = 24 to **Bottom** = 11.
 - c. The layer number 3 lies from **Top** = 11 to **Bottom** = 0.
3. Click the **Boreholes** button at the bottom of the **Modify soil layers** window.
4. In the appearing menu select the **Add** option.
The **Add borehole** window pops up.
5. Specify the location of the second borehole ($x = -14$).
6. Note that the soil layers are available for Borehole_2.
 - a. The layer number 1 has a depth equal to zero in Borehole_2. However as the depth of layer 2 is higher, assign 30.00 to **Top** and **Bottom** of the layer 1.
 - b. The layer number 2 lies from **Top** = 30 to **Bottom** = 11.
 - c. The layer number 3 lies from **Top** = 11 to **Bottom** = 0.
7. Create a new borehole (Borehole_3) at $x = -7$.
8. In Borehole_3:
 - a. The layer number 1 has a non-zero thickness and lies from **Top** = 35 to **Bottom** = 30.
 - b. The layer number 2 lies from **Top** = 30 to **Bottom** = 11.
 - c. The layer number 3 lies from **Top** = 11 to **Bottom** = 0.
9. In all the boreholes the water level is located at $y = 0$ m.
10. Specify the soil layer distribution as shown in [Figure 53](#) (on page 3).

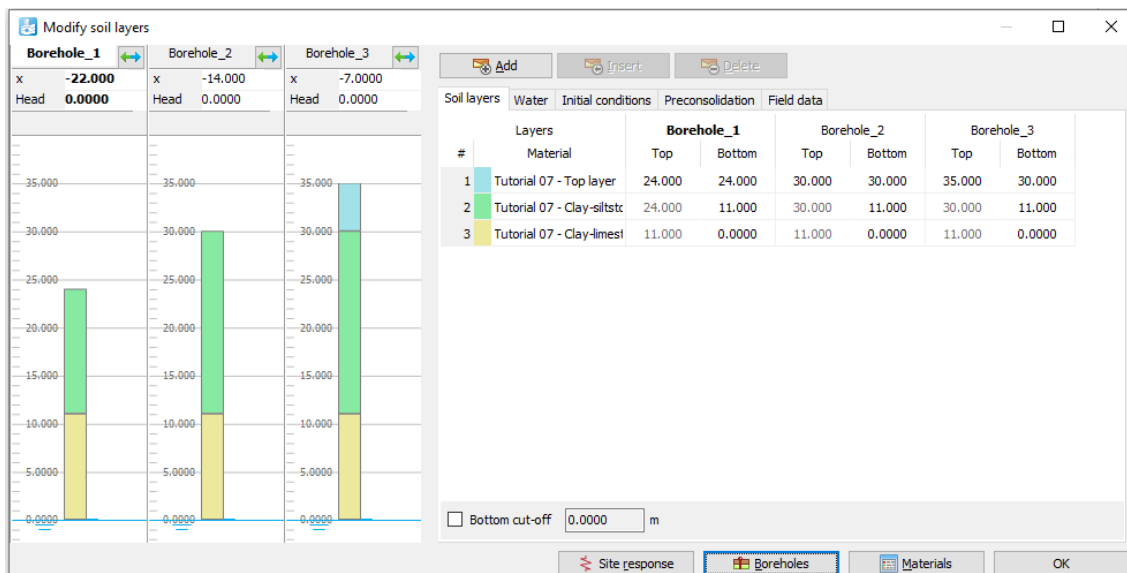

Figure 2: Soil layer distribution

Excavation of an NATM tunnel [GSE]

Create and assign material data sets

Create and assign material data sets

Three material sets need to be created for the soil layers.

Note that the layering of the model left from the first borehole is based on Borehole_1 and the layering right from the last borehole is based on Borehole_3. Hence, no borehole is needed at $x = -50$ m or $x = 50$ m.

The layers have the following properties:

Table 1: Material properties of the soil layer

Parameter	Name	Top layer	Unit
General			
Material model	-	Hardening soil	-
Type of material behaviour	-	Drained	-
Soil unit weight above phreatic level	γ_{unsat}	20	kN/m ³
Soil unit weight below phreatic level	γ_{sat}	22	kN/m ³
Parameters			
Secant stiffness in standard drained triaxial test	E_{50}^{ref}	$40 \cdot 10^3$	kN/m ²
Tangent stiffness for primary oedometer loading	E_{oed}^{ref}	$40 \cdot 10^3$	kN/m ²
Unloading / reloading stiffness	E_{ur}^{ref}	$120 \cdot 10^3$	kN/m ²
Power for stress-level dependency of stiffness	m	0.5	-
Poisson's ratio	ν_{ur}'	0.2	-
Cohesion	c_{ref}'	10	kN/m ²
Friction angle	φ'	30	°
Interfaces			
Interface strength	-	Rigid	-
Strength reduction factor	R_{inter}	1.0	-

Table 2: Material properties of the soft rock layers

Parameter	Name	Clay-siltstone	Clay-limestone	Unit
General				

Excavation of an NATM tunnel [GSE]

Define the tunnel

Parameter	Name	Clay-siltstone	Clay-limestone	Unit
Material model	-	Hoek-Brown	Hoek-Brown	-
Type of material behaviour	-	Drained	Drained	-
Soil unit weight above phreatic level	γ_{unsat}	25	24	kN/m ³
Soil unit weight below phreatic level	γ_{sat}	25	24	kN/m ³
Parameters				
Young's modulus	E_{rm}'	$1.0 \cdot 10^6$	$2.5 \cdot 10^6$	kN/m ²
Poisson's ratio	ν'	0.25	0.25	-
Uniaxial compressive strength	σ_{ci}	$25 \cdot 10^3$	$50 \cdot 10^3$	kN/m ²
Material constant for the intact rock	m_i	4	10	-
Geological Strength Index	GSI	40	55	-
Disturbance factor	D	0.2	0.0	-
Dilatancy parameter	ψ_{max}	30	35	°
Dilatancy parameter	σ_{ψ}	400	1000	kN/m ²
Interfaces				
Interface strength	-	Manual	Rigid	-
Strength reduction factor	R_{inter}	0.5	1.0	-









1. Create soil material data sets according to [Table 11](#) (on page 4) and assign them to the corresponding layers ([Figure 53](#) (on page 3)).
2. Close the **Modify soil layers** window and proceed to the **Structures** mode to define the structural elements.

Define the tunnel

1. In the **Structures** mode click the **Create tunnel** button  in the side toolbar and click on (0 16) in the drawing area to specify the location of the tunnel.
The **Tunnel designer** window pops up.
2. The default shape option (**Free**) will be used. The default values of the rest of the parameters defining the location of the tunnel in the model are valid as well.
3. Click on the **Segments** tab.

Excavation of an NATM tunnel [GSE]

Define the tunnel

4. Click the **Add section** button  in the side toolbar. In the segment info box
 - a. Set the **Segment type** to **Arc**.
 - b. Set **Radius** to 10.4 m
 - c. Set the **Segment angle** to 22°.
5. The default values of the remaining parameters are valid.
6. Click the **Add section** button  to add a new arc segment.
 - a. Set **Radius** to 2.4 m.
 - b. Set the **Segment angle** to 47°.
 - c. The default values of the remaining parameters are valid.
7. Click the **Add section** button  to add a new arc segment.
 - a. Set **Radius** to 5.8 m.
 - b. Set the **Segment angle** to 50°.
 - c. The default values of the remaining parameters are valid.
8. Click the **Extend to symmetry axis** option  to complete the right half of the tunnel. A new arc segment is automatically added closing the half of the tunnel.
9. Click the **Symmetric close** button  to complete the tunnel. Four new arc segment are automatically added closing the tunnel.
10. Click on the **Subsections** tab.
11. Click the **Add** button  to add a new subsection. This subsection will be used to separate the top heading (upper excavation cluster) from the invert (lower excavation cluster).
 - a. Set **Offset 2** to 3 m.
 - b. Select the **Arc** option from the **Segment type** drop-down menu.
 - c. Set **Radius** to 11 m.
 - d. **Segment angle** to 360°.
12. Click the **Select multiple objects** button  and select all the geometric entities in the slice.
13. Click the **Intersect** button .
14. Delete the part of the subsection outside of the slice by selecting it in the display area and clicking the **Delete** button  in the side toolbar.

Excavation of an NATM tunnel [GSE]

Define the tunnel

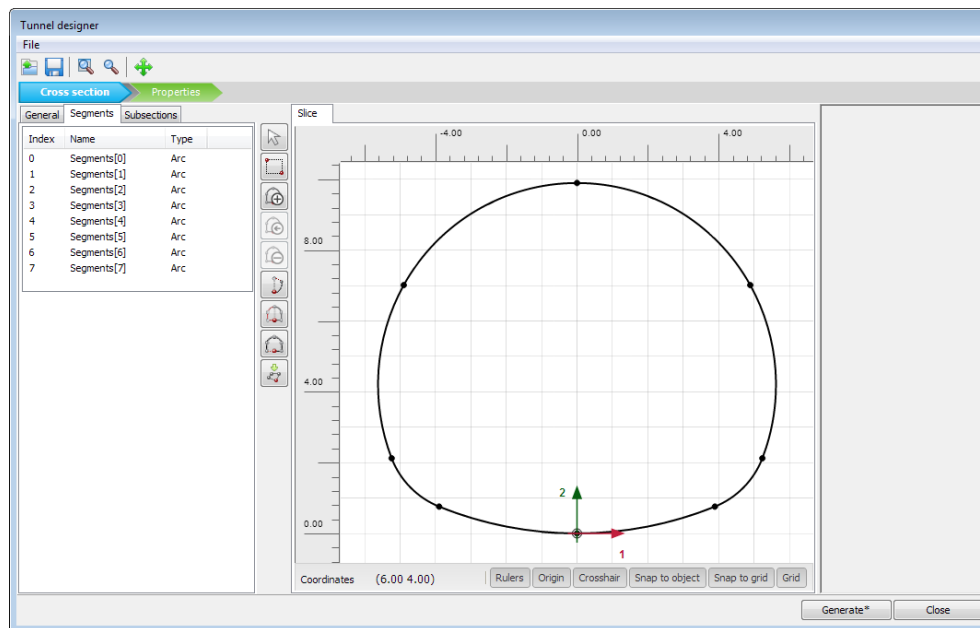

Figure 3: Segments in the tunnel cross section

15. Proceed to the **Properties** mode.
16. Multi-select the polycurves in the display area and select the **Create plate** option in the appearing menu.
17. Press **<Ctrl + M>** to open the **Material sets** window. Create a new material dataset for the created plates according to [Table 13](#) (on page 7).

Table 3: Material properties of the plates

Parameter	Name	Lining	Unit
Material type	-	Elastic	-
Isotropic	-	Yes	-
Axial stiffness	EA_1	$6.0 \cdot 10^6$	kN/m
Bending stiffness	EI	$20 \cdot 10^3$	kNm ² /m
Weight	w	5	kN/m/m
Poisson's ratio	ν	0.15	-
Prevent punching	-	No	-

18. Multi-select the created plates and in the **Selection explorer**, assign the material **Lining** to the selected plates.
19. Assign negative interfaces to the lines defining the shape of the tunnel (not the excavation levels). The final tunnel view in the **Tunnel designer** window is given in this figure:

Excavation of an NATM tunnel [GSE]

Generate the mesh

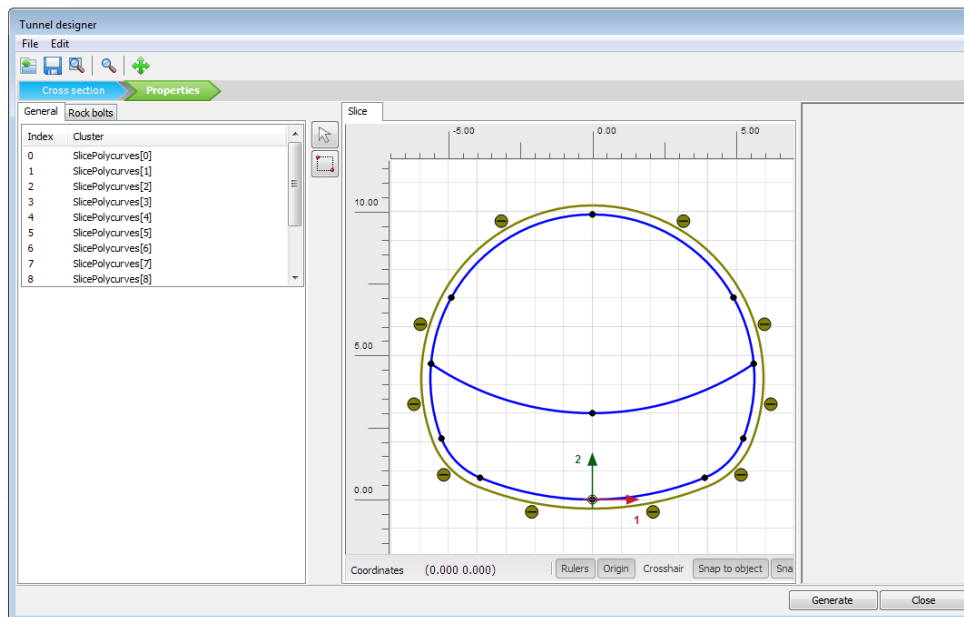



Figure 4: Final tunnel

20. Click on **Generate** to update the tunnel in the model and click **Close**.

Generate the mesh

The default global coarseness parameter (**Medium**) can be accepted in this case.

1. Proceed to the **Mesh** mode.
2. Click the **Generate mesh** button  in the side toolbar. For the **Element distribution** parameter, use the option **Medium** (default).
3. Click the **View mesh** button  to view the mesh.

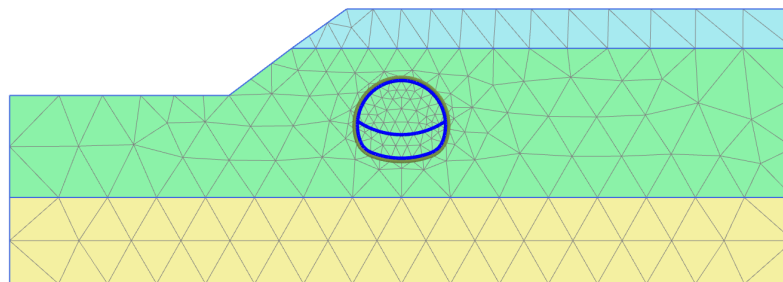

Figure 5: The generated mesh

4. Click the **Close** tab to close the Output program.

Define and perform the calculation

Excavation of an NATM tunnel [GSE]

Define and perform the calculation

To simulate the construction of the tunnel a staged construction calculation is needed in which the tunnel lining is activated and the soil clusters inside the tunnel are deactivated. The calculation phases are **Plastic analyses, Staged construction**. The three-dimensional arching effect is emulated by using the so-called β -method. The idea is that the initial stresses p_k acting around the location where the tunnel is to be constructed are divided into a part $(1-\beta) p_k$ that is applied to the unsupported tunnel and a part **Deconfinement** method that is applied to the supported tunnel.

To apply this method in PLAXIS 2D, one can use the **Deconfinement** option, which is available for each de-activated soil cluster in the model explorer. **Deconfinement** is defined as the aforementioned factor $(1-\beta)$. For example, if 60% of the initial stresses in a de-activated soil cluster should disappear in the current calculation phase (so the remaining 40% is to be considered later), it means that the **Deconfinement** $(1-\beta)$ parameter of that inactive cluster should be set to 60%. The value of **Deconfinement** can be increased in subsequent calculation phases until it reaches 100%.

To define the calculation process follow these steps:

Initial phase

1. Click on the **Staged construction** tab to proceed with the definition of the calculation phases.
2. The initial phase has already been introduced. Note that the soil layers are not horizontal. It is not recommended in this case to use the **K0 procedure** to generate the initial effective stresses. Instead **Gravity loading**  will be used. This option is available in the **General** subtree of the **Phases** window.
3. Water will not be considered in this example. The general phreatic level should remain at the model base.
4. Make sure that the tunnel is inactive.

Phase 1: First tunnel excavation (deconfinement)

1. Click the **Add phase** button  to create a new phase.
2. In the **Staged construction** mode deactivate the upper cluster in the tunnel. Do NOT activate the tunnel lining.
3. While the de-activated cluster is still selected, in the **Selection explorer** set **Deconfinement** $(1 - \beta)$ to 60 %.

The model for Phase 1 is displayed in the figure below.

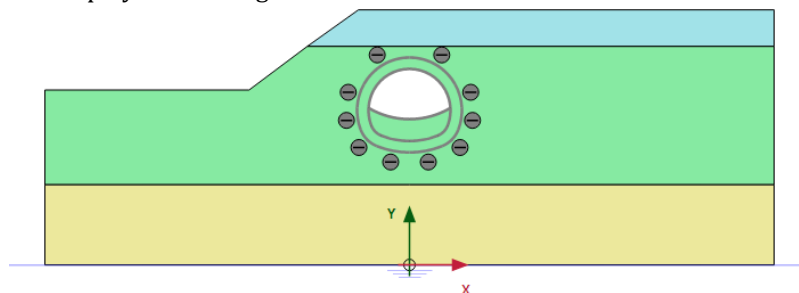



Figure 6: Configuration of Phase 1

Excavation of an NATM tunnel [GSE]

Define and perform the calculation

Phase 2: First (temporary) lining

1. Click the **Add phase** button  to create a new phase.
2. In the **Staged construction** mode, activate the lining and interfaces of the part of the tunnel excavated in the previous phase.
3. Select the de-activated cluster. In the **Selection explorer** set **Deconfinement** to 100 %.

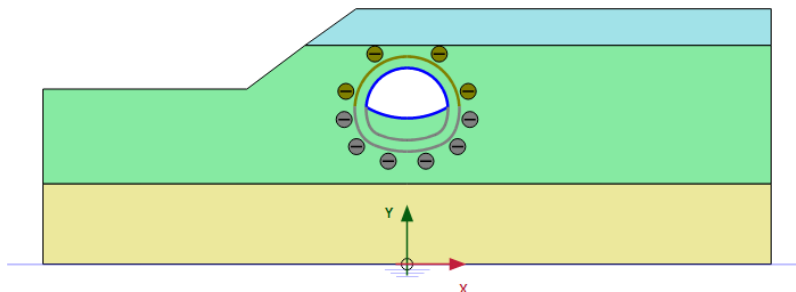



Figure 7: Configuration of Phase 2

Phase 3: Second tunnel excavation (deconfinement)

1. Click the **Add phase** button  to create a new phase.
2. In the **Staged construction** mode deactivate the lower cluster (invert) and the temporary lining in the middle of the tunnel.
3. While the lower de-activated cluster is still selected, set in the **Selection explorer Deconfinement** to 60%.

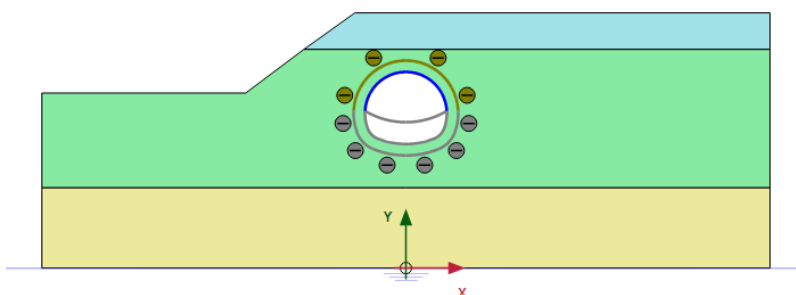



Figure 8: Configuration of Phase 3

Phase 4: Second (final) lining

1. Click the **Add phase** button  to create a new phase.
2. Activate the remaining lining and interfaces.
All the plates and interfaces around the full tunnel are active.
3. Select the lower de-activated cluster. In the **Selection explorer** set **Deconfinement** to 100 %.

Excavation of an NATM tunnel [GSE]

Results

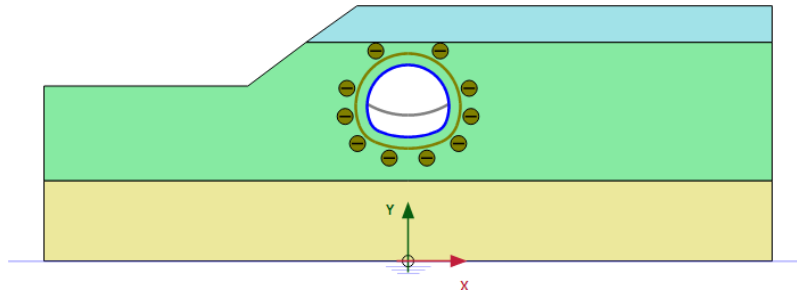





Figure 9: Configuration of Phase 4

Execute the calculation

1. Click the **Select points for curves** button  in the side toolbar.
2. Select a node at the slope crest point and the tunnel crest. These points might be of interest to evaluate the deformation during the construction phases.
3. Click the **Calculate** button  to calculate the project.
4. After the calculation has finished, save the project by clicking the Save button .

Results

After the calculation, select the last calculation phase and click the **View calculation results** button. The **Output** program is started, showing the deformed mesh at the end of the calculation phases:

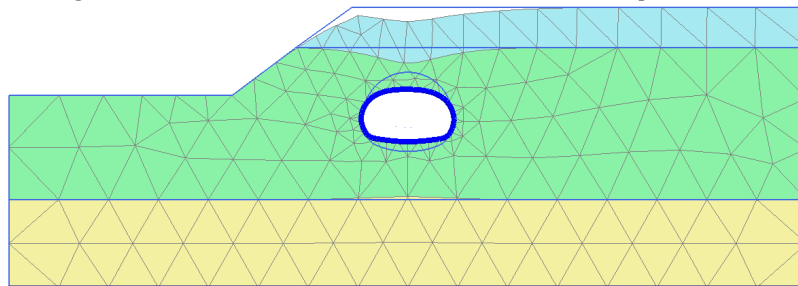



Figure 10: The deformed mesh at the end of the final calculation phase

To display the bending moments resulting in the tunnel:

Excavation of an NATM tunnel [GSE]

Results

1. To select the lining of all the tunnel sections, click the corresponding button  in the side toolbar and drag the mouse to define a rectangle where all the tunnel sections are included. Select the **Plate** option in the

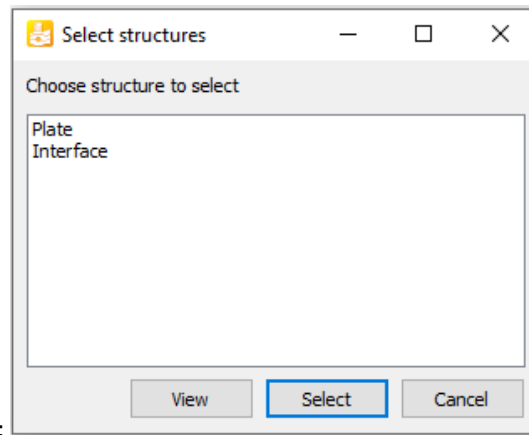

appearing window:

and click **View**.

Note that the tunnel lining is displayed in the **Structures** view.

2. From the **Forces** menu select the **Bending moment M** option. The result, scaled by a factor of 0.5 is displayed in the figure below.

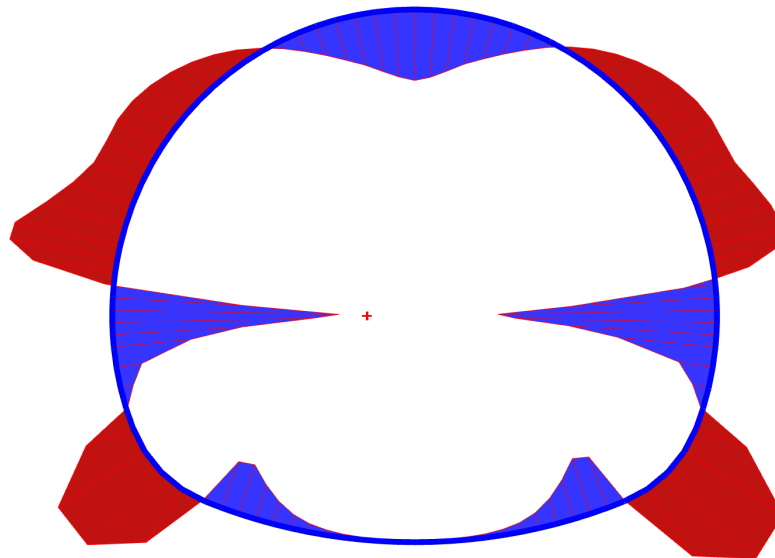

Figure 11: Resulting bending moments in the NATM tunnel